



Catalog Number	
Project	Type

Features & Specifications

Application

This fixture is designed for suspension mounting for direct/indirect applications where aesthetics and performance are both needed. Virtually glare free and shadow free illumination.

Features

Designed to mount on exact 4 foot, 8 foot, and 12 foot centers. Joiners will accept stems, single cable, and power cords as supplied by Horizon. Two die cast aluminum architectural ends available (Spade, Bull Nose). Each fixture is shipped with a sleeve that allows for the adjustment of up/down light to:

20% Up / 80% Down;

60% Up / 40% Down;

or 100% Down

Construction

Heavy gauge roll formed steel housing with perforated pattern. Units are shipped with die cast aluminum joiners installed for suspension and structural continuity.

Electrical System

ETL listed. Suitable for damp locations. Damp location emergency pack must be specified separately. Ballasts are solid-state electronic. Ballasts and lamp holders are replaceable without removing from ceiling. Discrete voltage must be specified for emergency pack options when wired with flex.

Finish

All reflective surfaces are finished with a high reflectance, lighting fixture white polyester powder.

PLL SERIES PERFORATED LINEAR

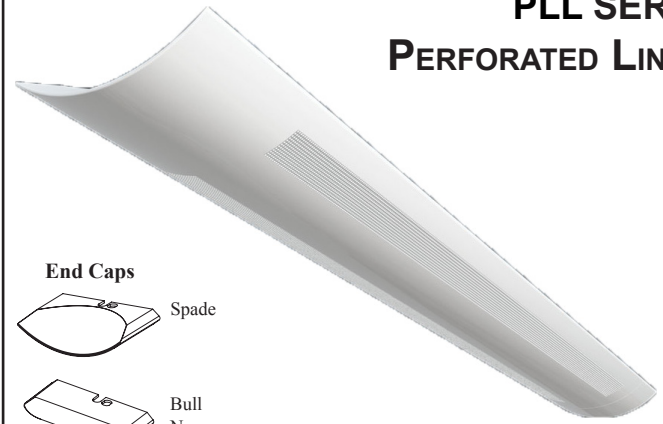

End Caps

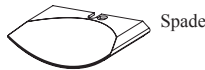

Spade

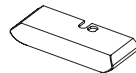

Bull
Nose

*End Caps must be ordered separately. See Page 2 for ordering information

DIMENSIONS

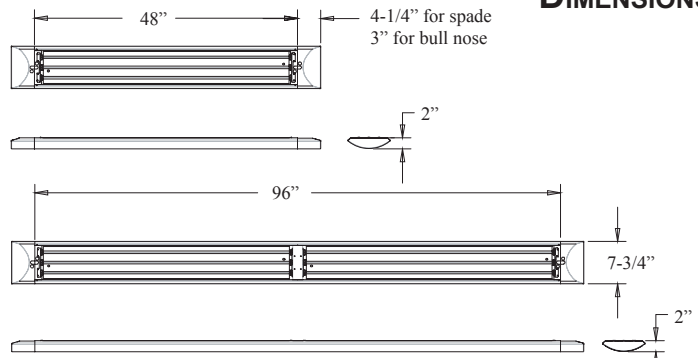

Please contact your Horizon Sales Representative for more information.
All dimensions subject to change without notice.

Ordering Nomenclature

Ex: (Peforated Linear, 2 Lamps, F32T8, 100% Down Light, White, Multi-Volt = PLL232WD) *End Caps must be ordered separately. See Page 2 for ordering information

--	--	--	--	--	--	--

SERIES PLL	NUMBER OF LAMPS PER CROSS SECTION	WATTAGE/TYPE	FIXTURE COLOR	VOLTAGE	BALLAST FACTOR	OPTIONS
For tandem double-length unit, add suffix T Ex: PLLT	1	32 - 32W T8, 48" (Note: 32W only available in 1 and 2 lamp configurations.)	BLANK - White	D - Multi-Volt 1 - 120V 2 - 277V 3 - 347V 4 - 480V	BLANK - Normal H - High L - Low	10RS - ≤10% THD, Rapid Start P - Program Start 20 - ≤20% THD EB5 - 500 Lumen Emergency Ballast EB7 - 700 Lumen Emergency Ballast EB14 - 1400 Lumen Emergency Ballast EB30 - 3000 Lumen Emergency Ballast FBF - Fast-Blow Fuse SBF - Slow-Blow Fuse AC63 - 6', 3/8" dia., Armored Flex Cable SJ6 - 6', 3/8" dia., 16/3 SJ Cord SJ10 - 10', 3/8" dia., 16/3 SJ Cord SJ15 - 15', 3/8" dia., 16/3 SJ Cord PWO - Palletized without Cartons CD - Continuous Dimming (T8) SD - Step Dimming (T8) WOC - 120/347 Volt Sensor WOC1- 480 Volt Sensor
	2	54 - 54W T5HO, 46"	T - Titanium	*Multi-Volt is 120/277V		
	3		B - Black			

ADDITIONAL OPTIONS

- WH34- Wiring Harness 3-Wire 4-Foot
- WH44- Wiring Harness 4-Wire 4-Foot
- WH54- Wiring Harness 5-Wire 4-Foot
- WH38- Wiring Harness 3-Wire 8-Foot
- WH48- Wiring Harness 4-Wire 8-Foot
- WH58- Wiring Harness 5-Wire 8-Foot

*See Second Page for End Cap and Pendant Information

Energy Saving Tip!
Our Occupancy Sensor option instantly turns lights on and off

- C1 - 6' Cord w/120V Nema Plug 16/3 15A
- C2 - 6' Cord w/277V Nema Plug 16/3 15A
- C3 - 10' Cord w/277V Nema Plug 16/3 20A
- C4 - 6' Cord w/480V Nema Plug 16/3 20A

SPADE

BULL NOSE

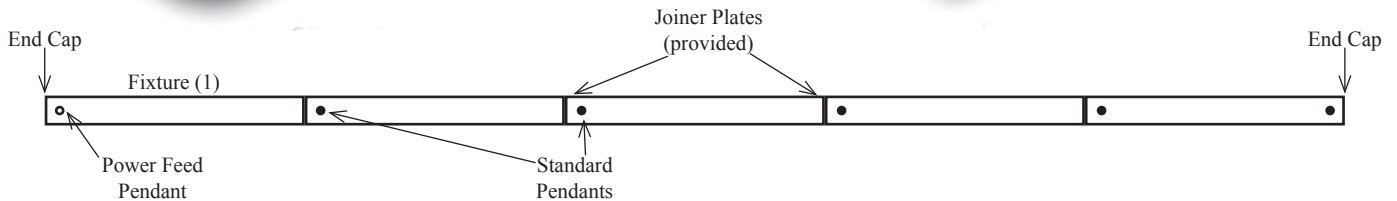
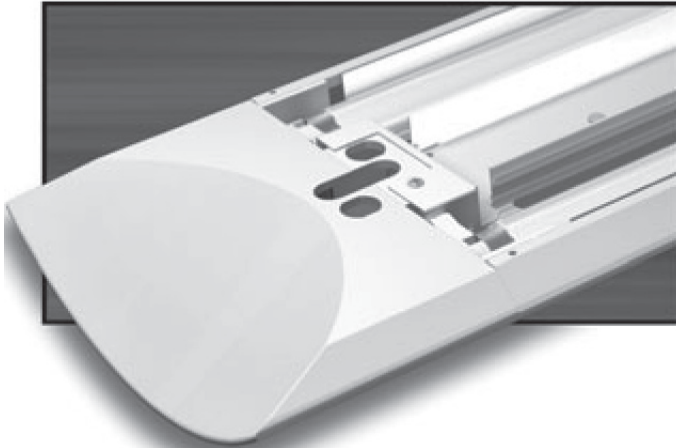

End Caps and Joiner Plates

The Horizon Perforated Linear fixture was designed to be mounted as either a stand-alone fixture, or mounted end-to-end for continuous linear rows. The mounting configuration will determine the number of end caps and joiner plates needed to complete an installation.

End Caps should be ordered 2 per fixture for stand-alone fixtures or 2 per row for continuous linear rows (# of fixtures x 2, or # of rows x 2). Joiner Plates should be ordered as 1 per the number of fixtures in each row minus 1 (# of fixtures per row minus one)

Part Number	Description
SEC	Spade Nose End Cap (one)
BNEC	Bull Nose End Cap (one)

Pendants

Power feed pendants should be ordered 1 per row for continuous linear rows (# of rows x 1). Non-power feed pendants should be ordered 1 per fixture for continuous linear rows (# of fixtures x 1).

Part Number	Description
PMNWXX	Rigid pendant - no power feed
PMWWXX	Rigid pendant with power feed wireway
CPNWXX	Aircraft Cable pendant - no power feed
CPWWXX	Aircraft Cable pendant with power feed wireway

"XX" Denotes pendant length. Order as 12", 15", 18", 21", 24" or 27" lengths.

Typical Row Configurations

	Row Length	4'	8'	12'	16'	20'	24'	28'	32'	36'	40'	44'	48'
Fixture Length	4'	1		1		1		1		1		1	
	8'		1	1	2	2	3	3	4	4	5	5	6
Power Feed Pendant		1	1	1	1	1	1	1	1	1	1	1	1
Non-Power Pendant		1	1	2	2	3	3	4	4	5	5	6	6
End Caps		2	2	2	2	2	2	2	2	2	2	2	2
Joiner Plates				1	1	2	2	3	3	4	4	5	5

POLAR GRAPH

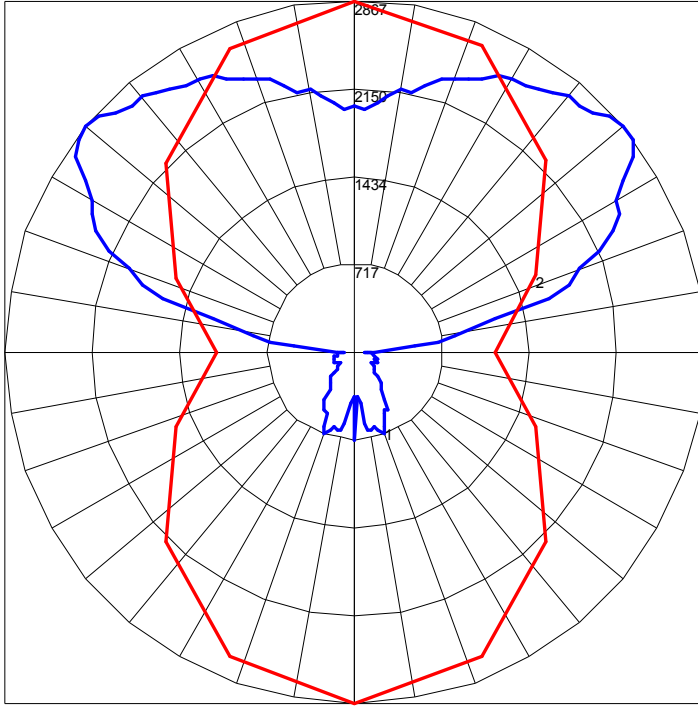

Maximum Candela = 2867 Located At Horizontal Angle = 90, Vertical Angle = 130
1 - Vertical Plane Through Horizontal Angles (90 - 270) (Through Max. Cd.)
2 - Horizontal Cone Through Vertical Angle (130) (Through Max. Cd.)